

HOW TO DRAFT THE TIPPED CONE

Rebecca B. Bennett

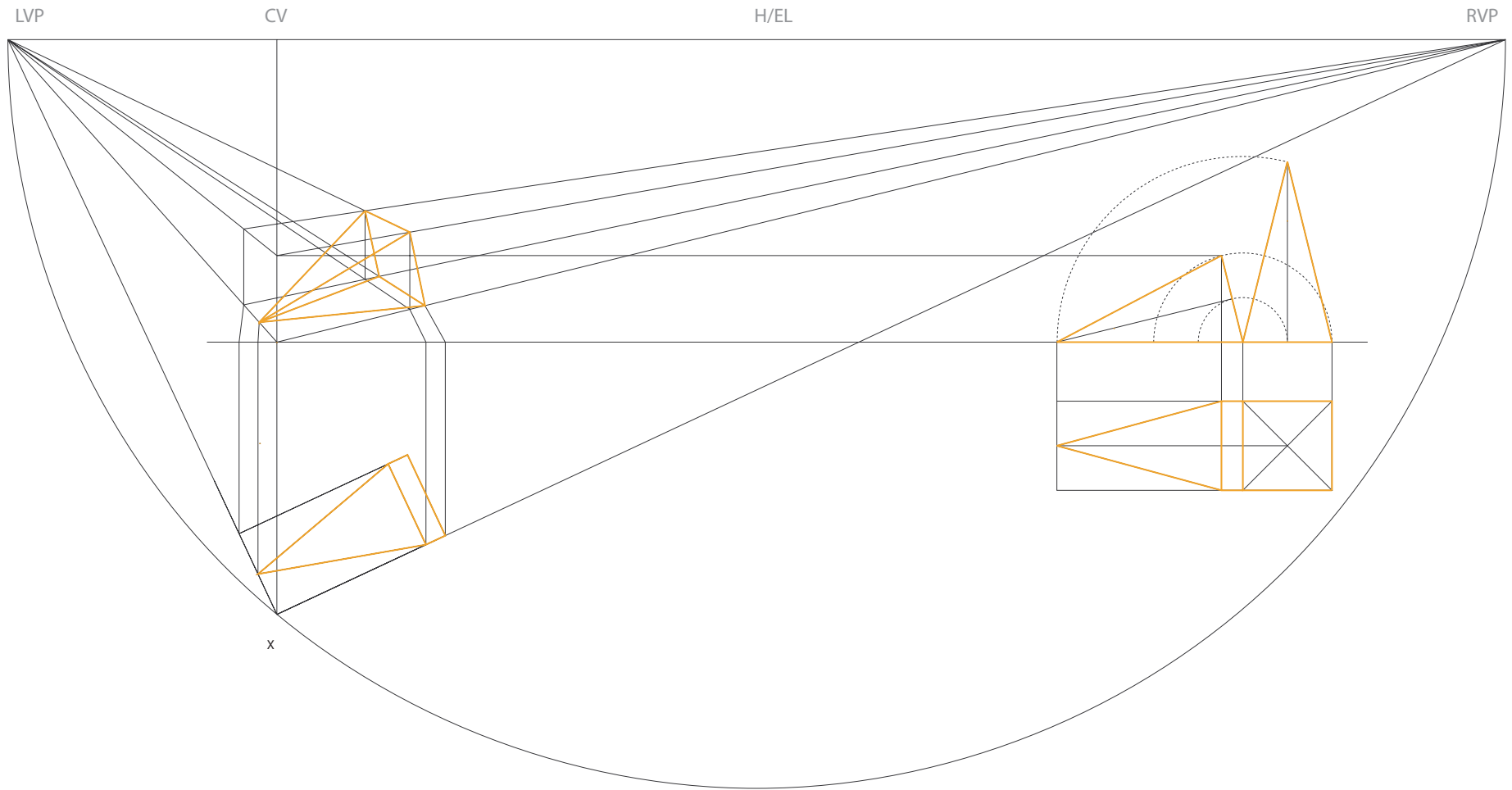

step 1
Draft a pyramid.

HOW TO DRAFT THE TIPPED CONE

Rebecca B. Bennett

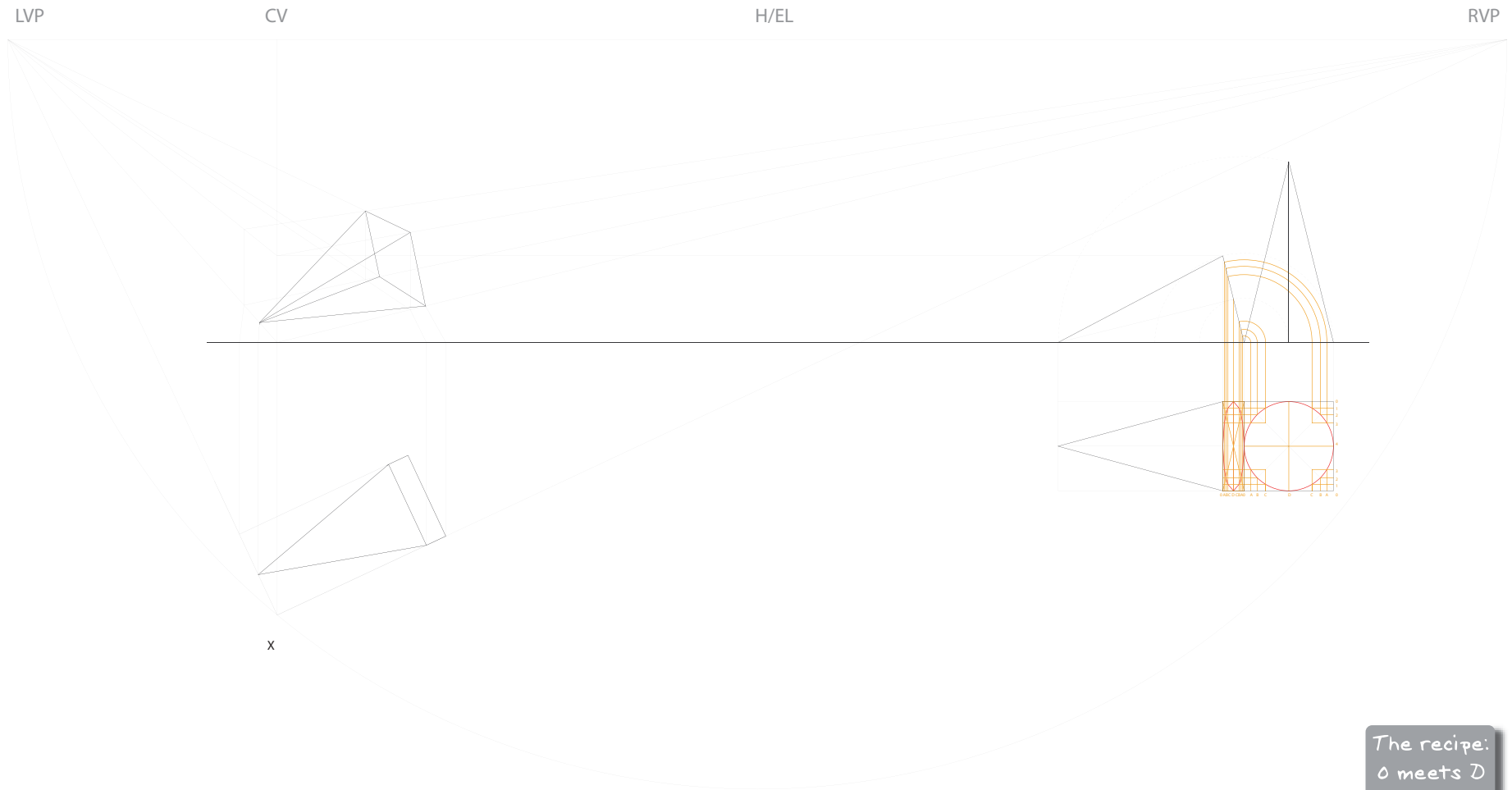

step 2
Draft the plan of the cone inside the plan of the pyramid.

The recipe:
0 meets D
1 meets C
2 meets B
3 meets A
4 meets 0

HOW TO DRAFT THE TIPPED CONE

Rebecca B. Bennett

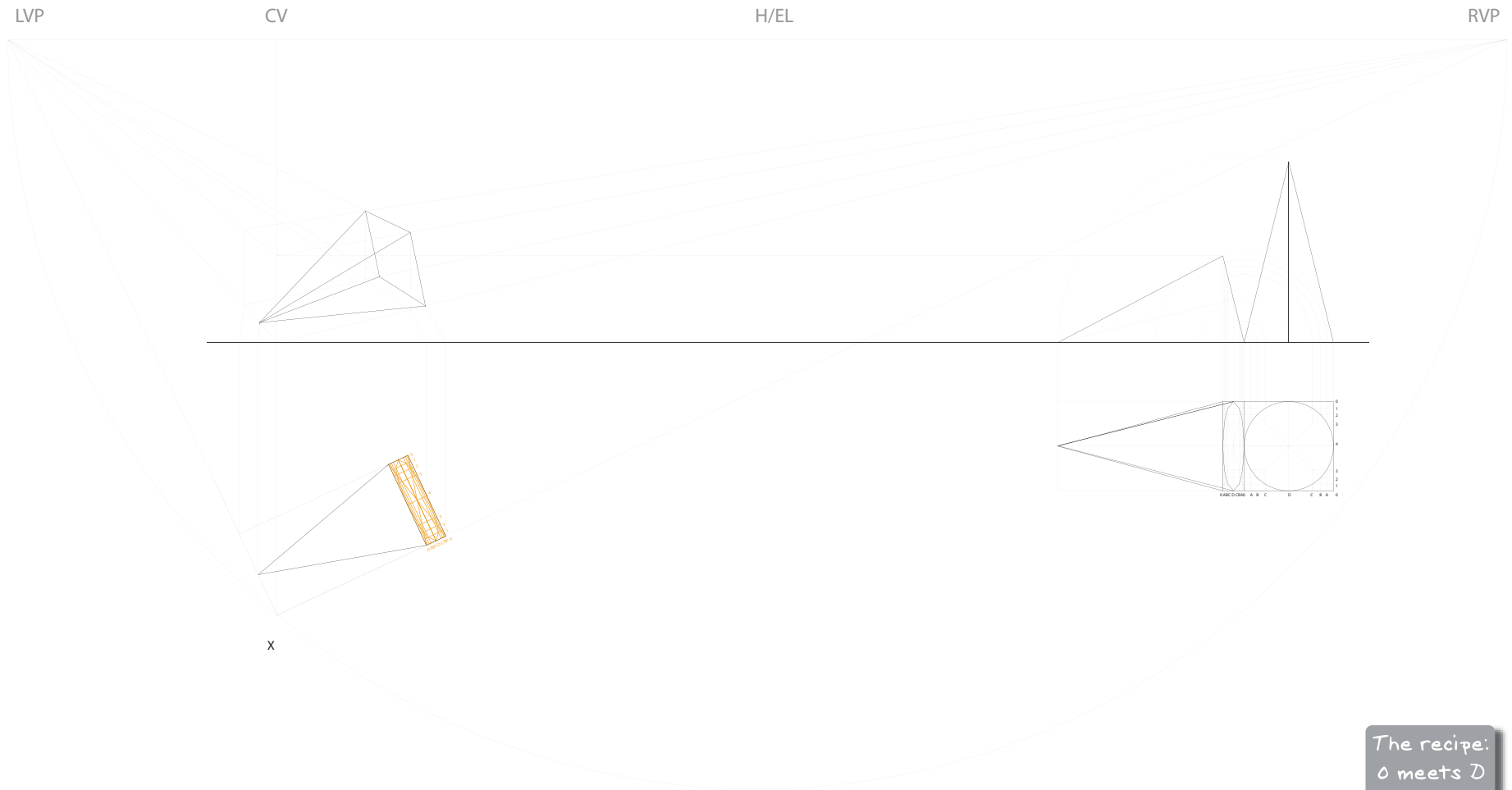

step 3
Transfer the grid to the plan at X.

The recipe:
0 meets D
1 meets C
2 meets B
3 meets A
4 meets 0

HOW TO DRAFT THE TIPPED CONE

Rebecca B. Bennett

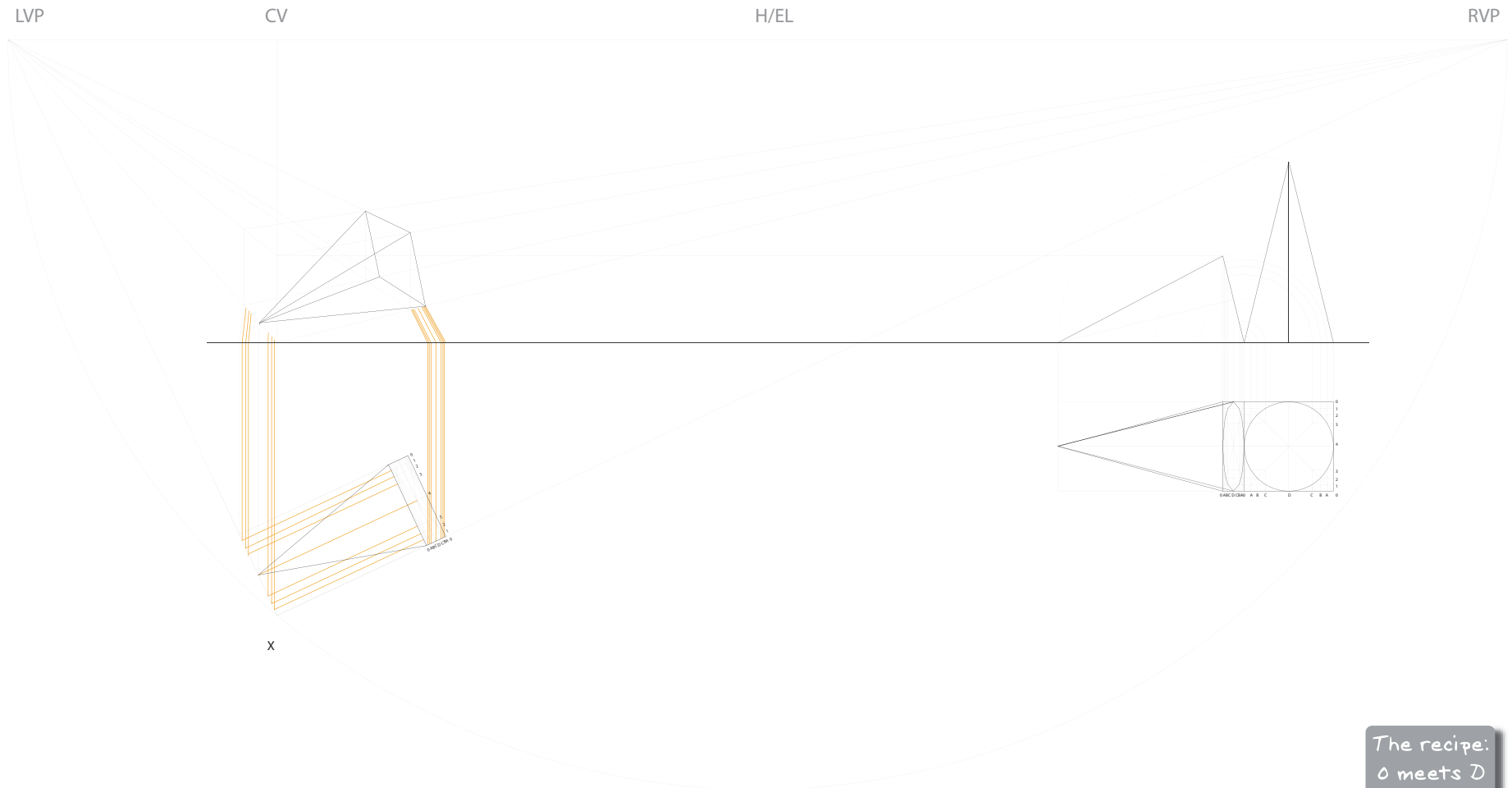

step 4
Extend lines from intersections lines X to the GL. Extend lines from intersections on GL to the CV.

The recipe:
0 meets D
1 meets C
2 meets B
3 meets A
4 meets O

HOW TO DRAFT THE TIPPED CONE

Rebecca B. Bennett

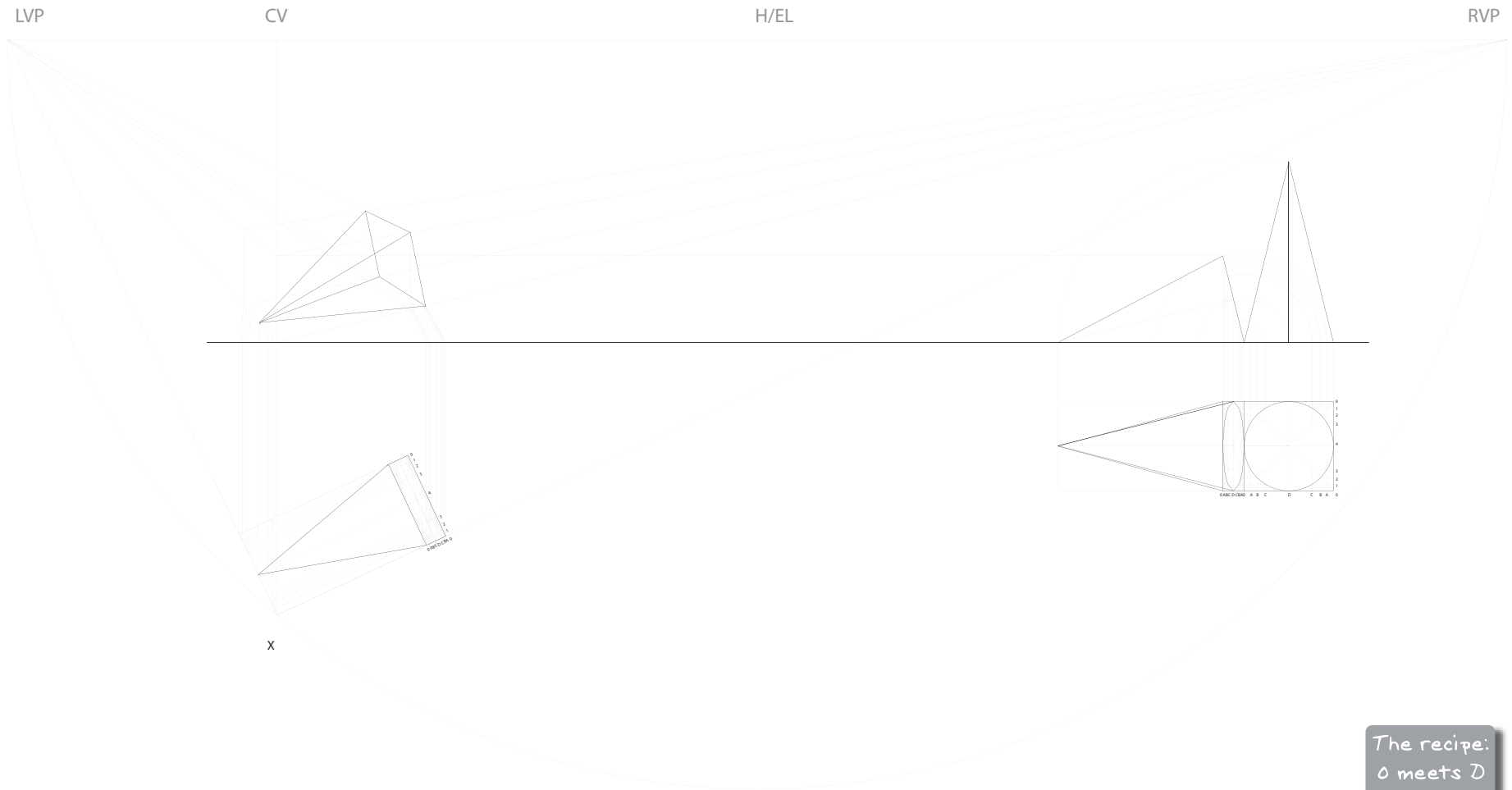

step 5
Label the points in the 3D area.

The recipe:
0 meets D
1 meets C
2 meets B
3 meets A
4 meets 0

HOW TO DRAFT THE TIPPED CONE

Rebecca B. Bennett

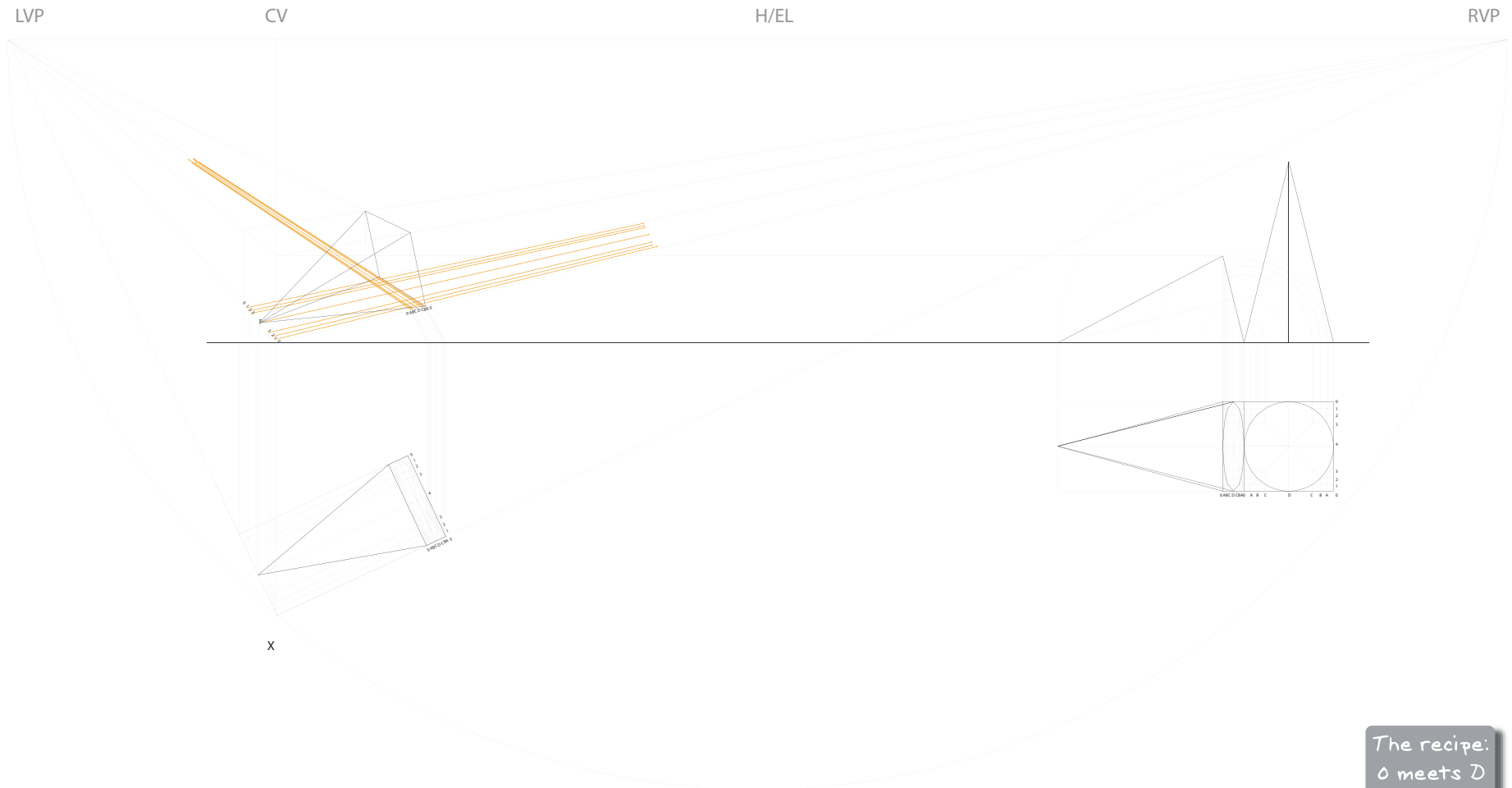

step 6
Extend the intersections back to the opposite VPs.

The recipe:
0 meets D
1 meets C
2 meets B
3 meets A
4 meets 0

HOW TO DRAFT THE TIPPED CONE

Rebecca B. Bennett

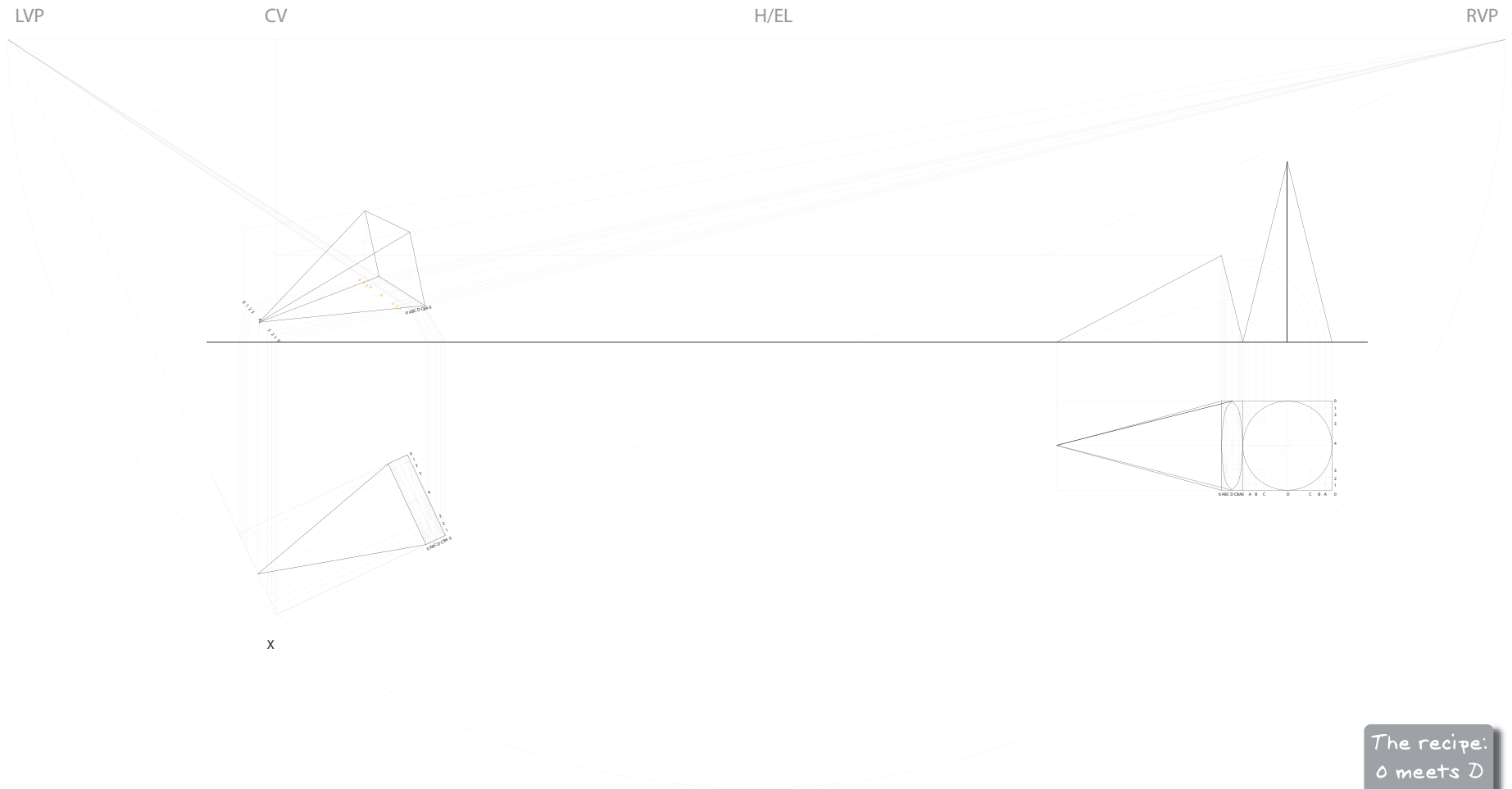

step 7
Find and label the grid at the base of the collapses cone base.

The recipe:
0 meets D
1 meets C
2 meets B
3 meets A
4 meets 0

HOW TO DRAFT THE TIPPED CONE

Rebecca B. Bennett

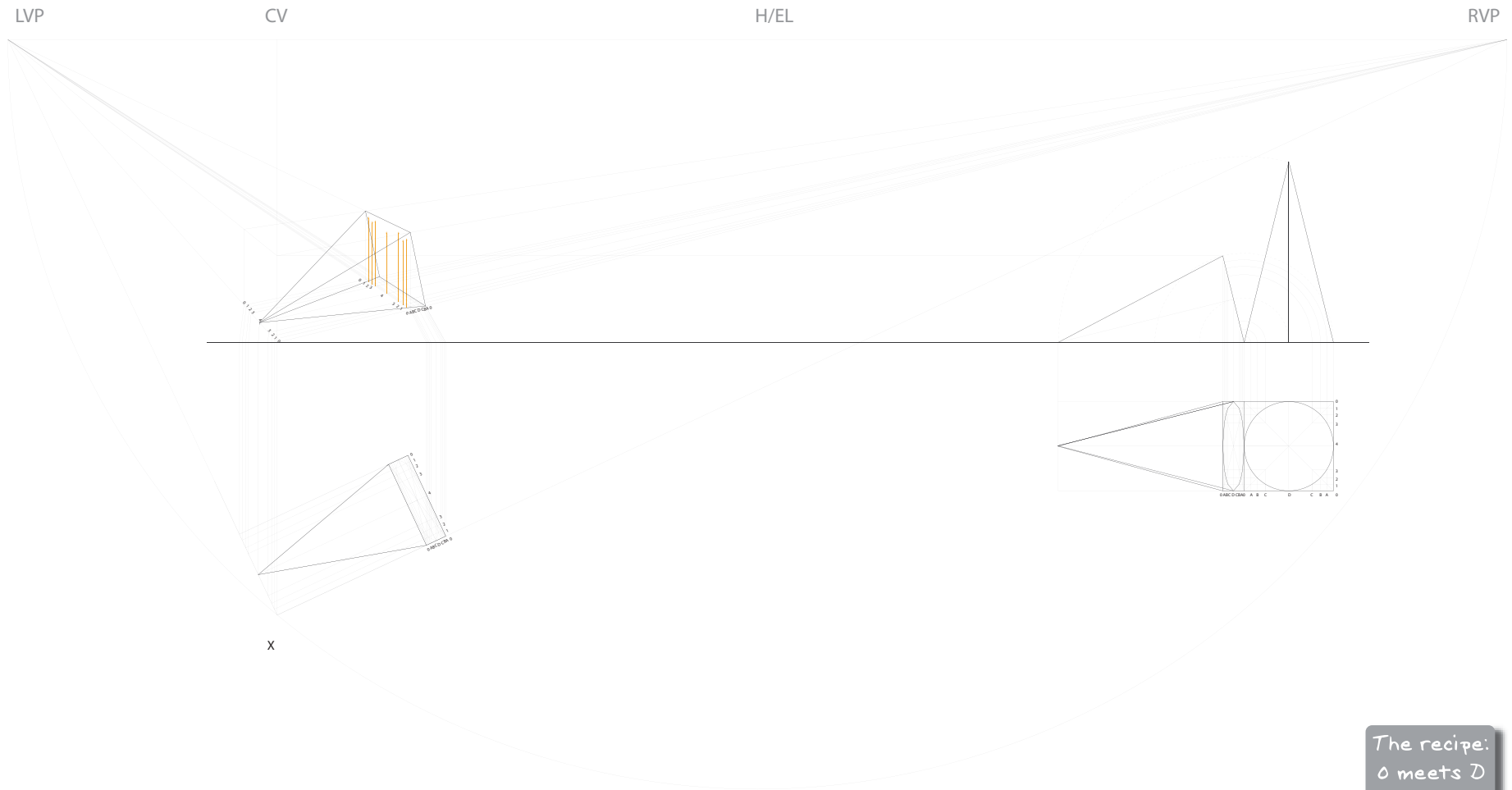

step 8

Extend intersections along the new line 0 up to the top of the tipped pyramid (or the elevated 0 line).

The recipe:
0 meets D
1 meets C
2 meets B
3 meets A
4 meets 0

HOW TO DRAFT THE TIPPED CONE

Rebecca B. Bennett

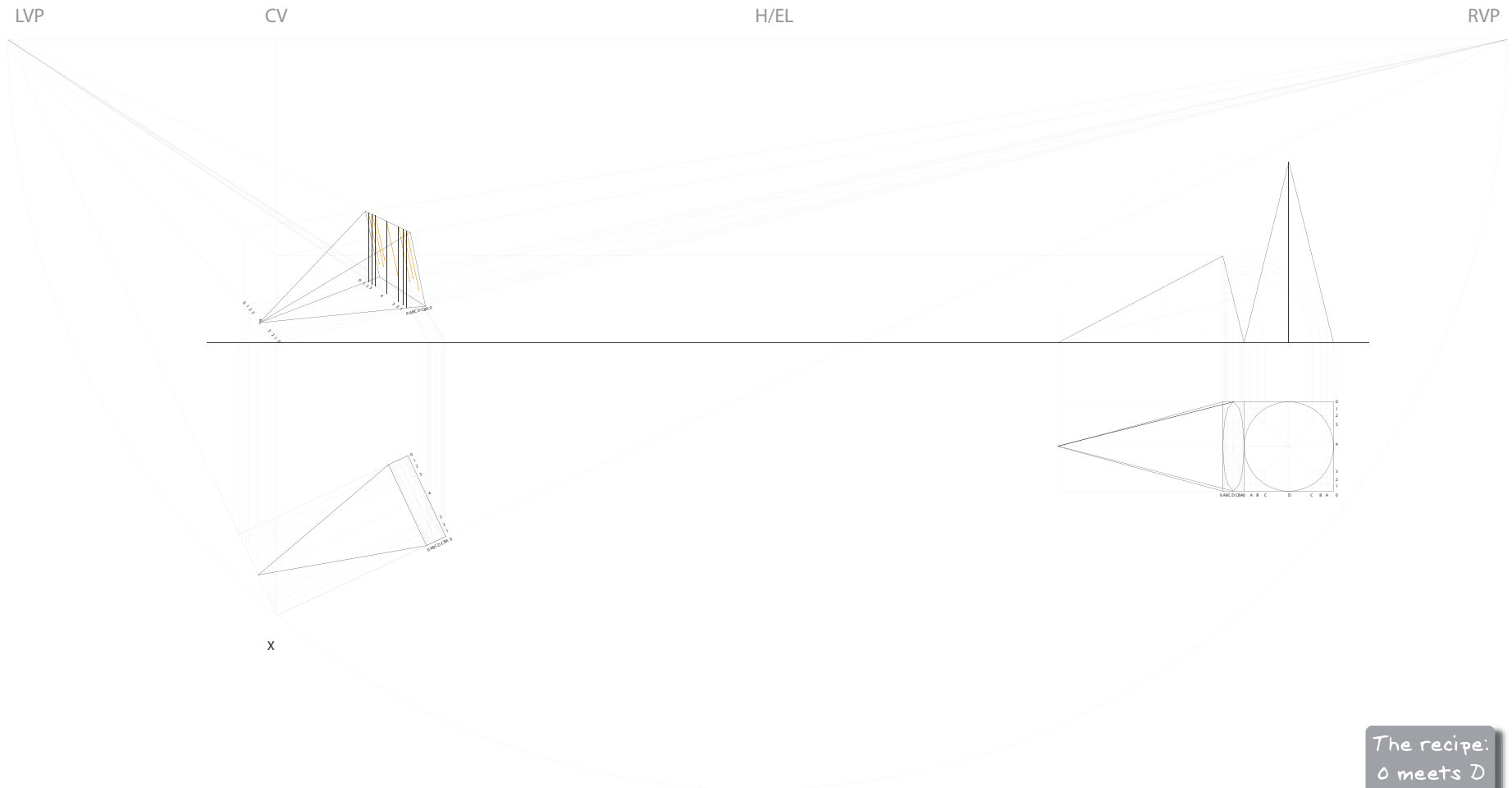

step 9

Connect the elevated points along 0 line to corresponding points on the back 0 line.

The recipe:
0 meets D
1 meets C
2 meets B
3 meets A
4 meets 0

HOW TO DRAFT THE TIPPED CONE

Rebecca B. Bennett

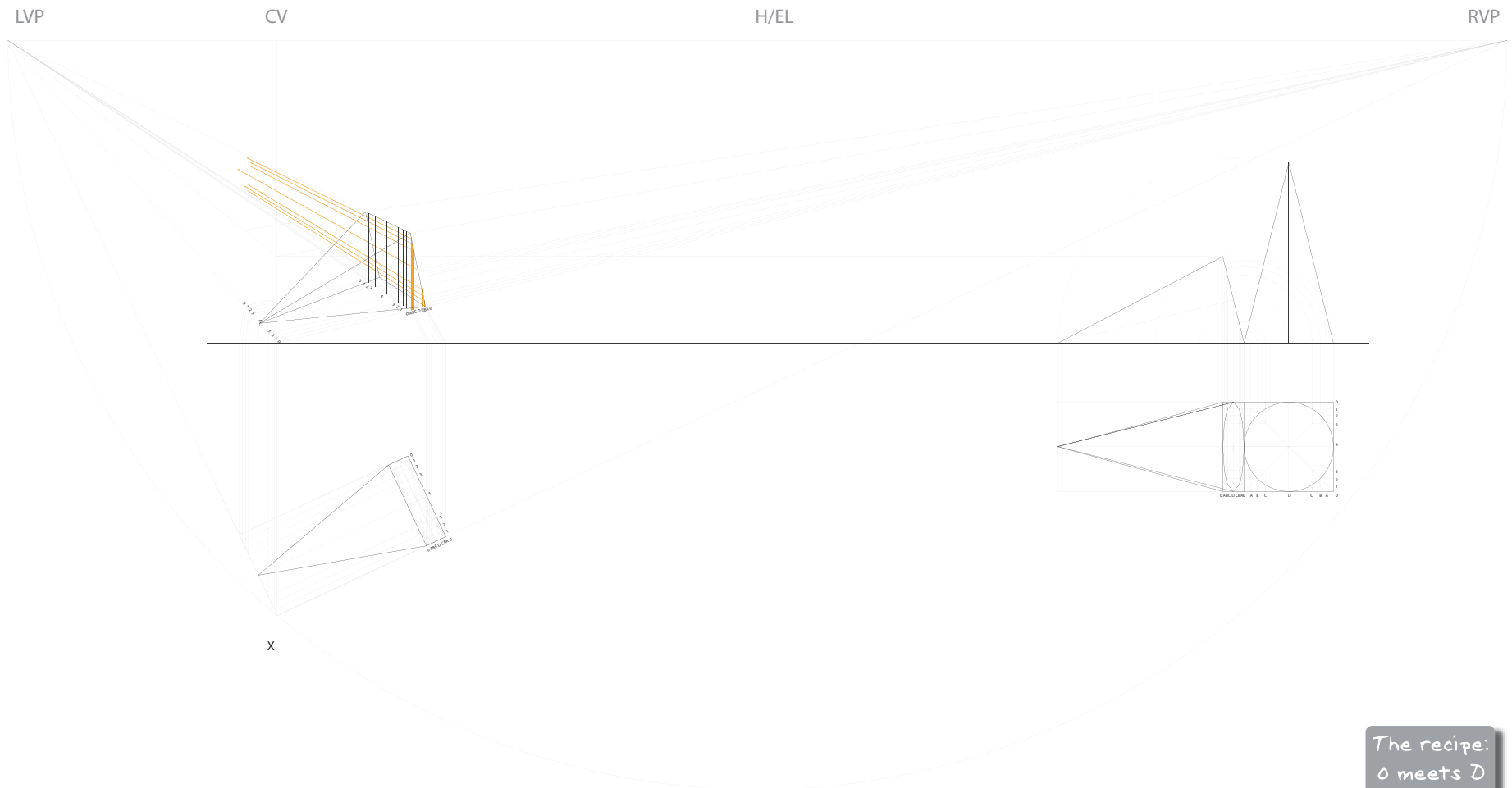

step 10

Extend lines from the letter points of the 0 line to the back edge of the pyramid. From those intersections, create lines going back to the opposite VP.

The recipe:
0 meets D
1 meets C
2 meets B
3 meets A
4 meets 0

HOW TO DRAFT THE TIPPED CONE

Rebecca B. Bennett

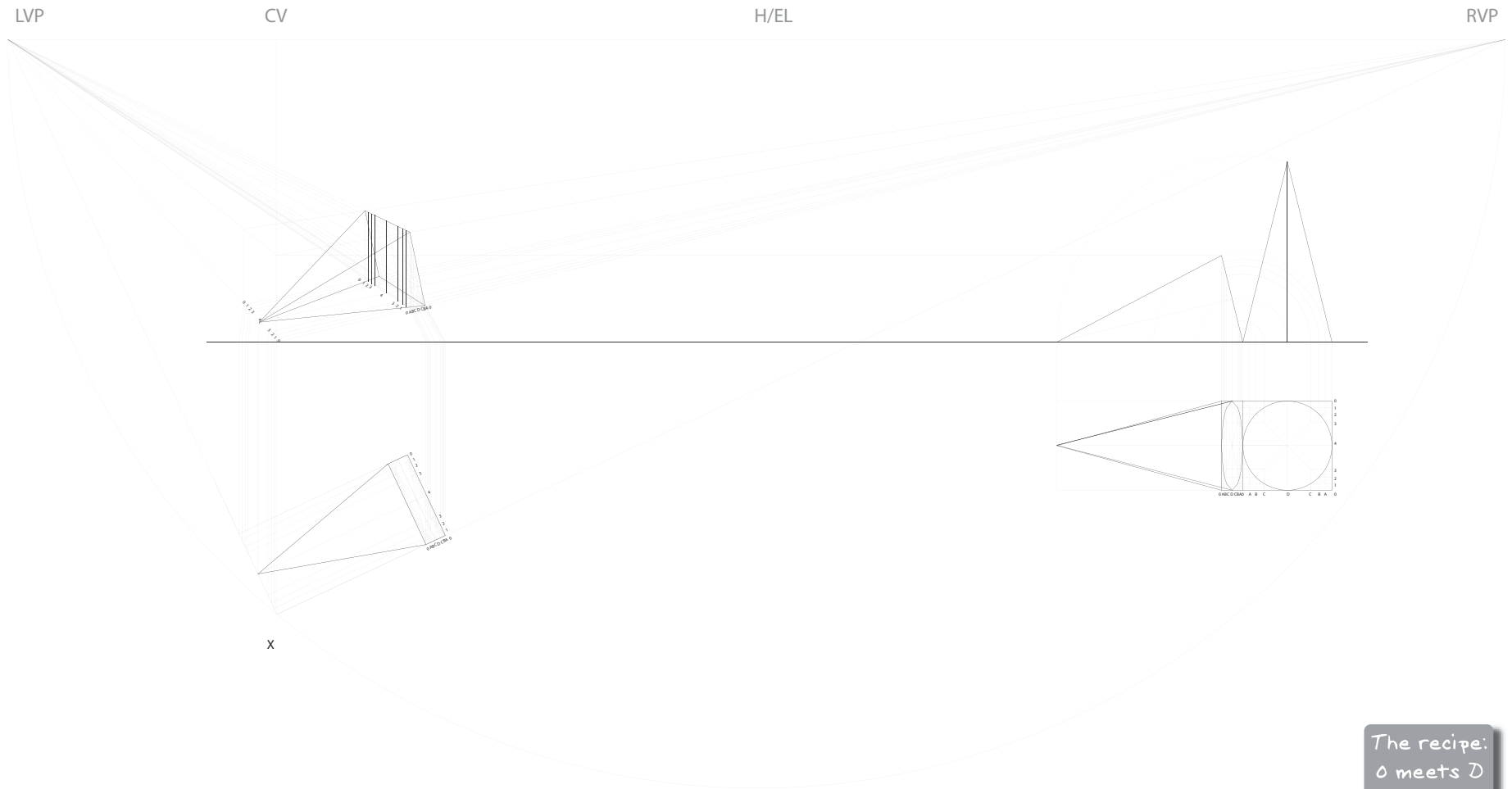

step 11
Using the recipe, find all the intersections.

The recipe:
 0 meets D
 1 meets C
 2 meets B
 3 meets A
 4 meets 0

HOW TO DRAFT THE TIPPED CONE

Rebecca B. Bennett

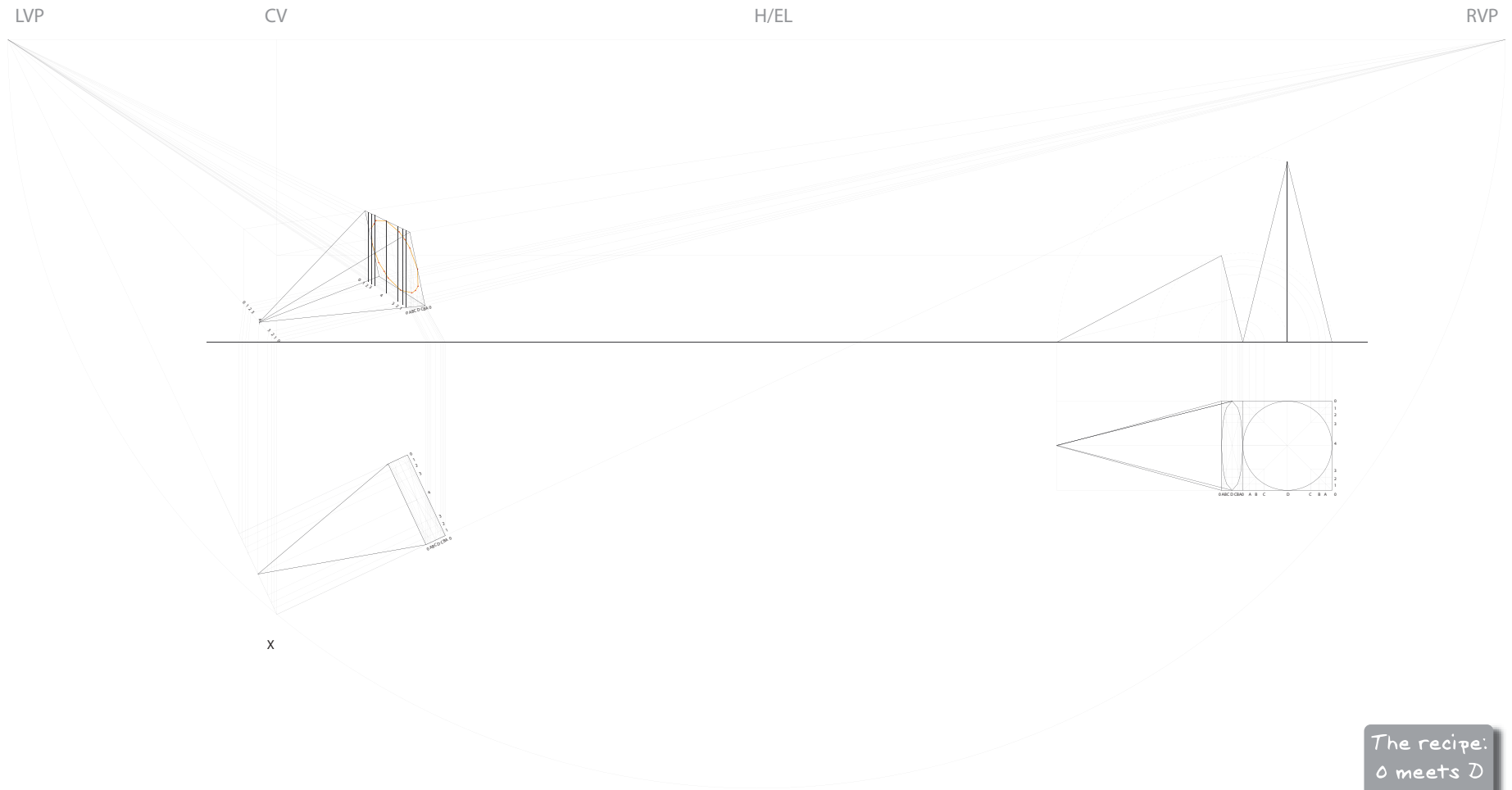

step 12
Connect the intersections.

The recipe:
0 meets D
1 meets C
2 meets B
3 meets A
4 meets O

HOW TO DRAFT THE TIPPED CONE

Rebecca B. Bennett

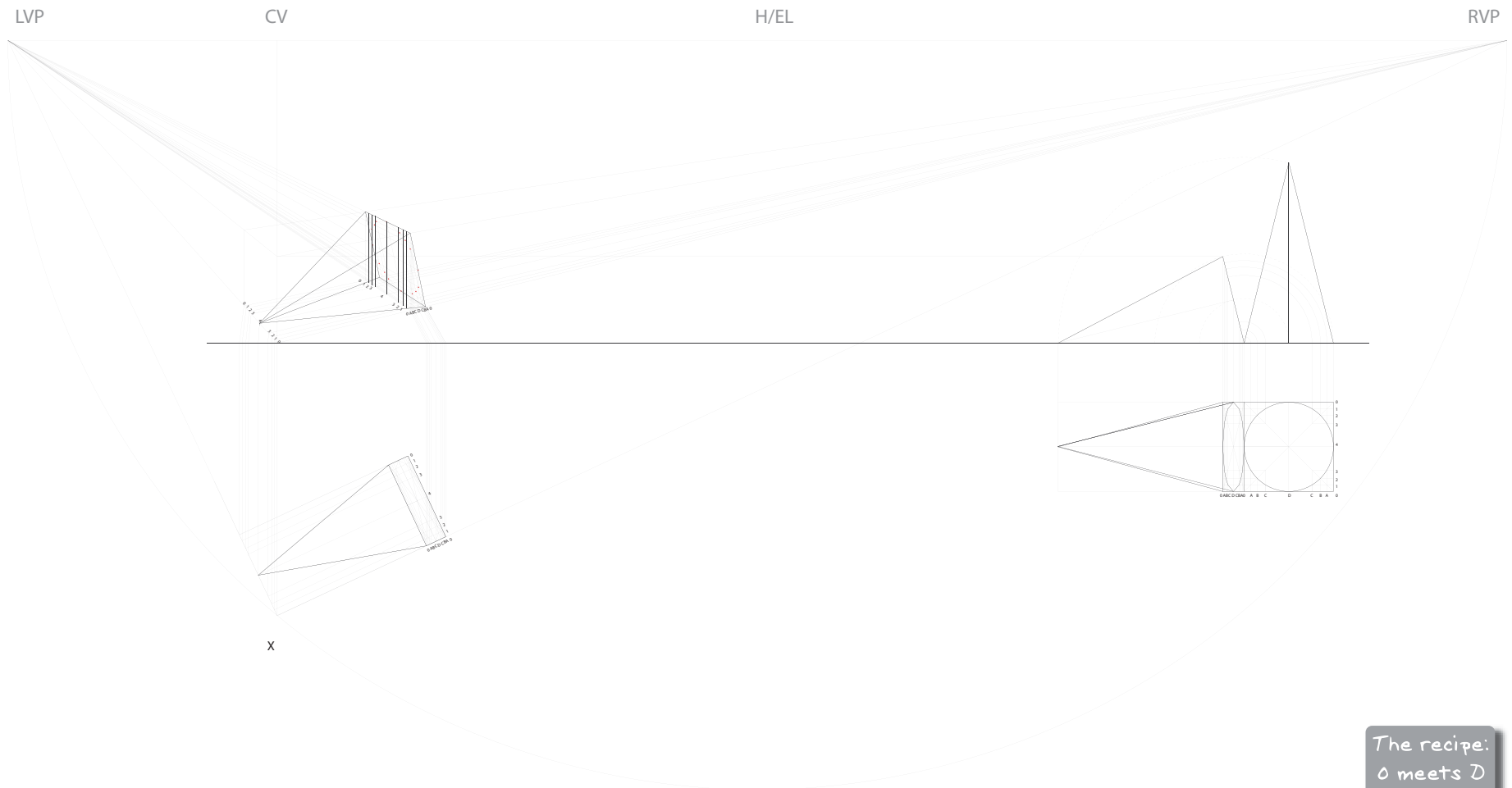

step 13
Connect up the sides of the cylinder and adjust line weight.

The recipe:
0 meets D
1 meets C
2 meets B
3 meets A
4 meets O

HOW TO DRAFT THE TIPPED CONE

Rebecca B. Bennett

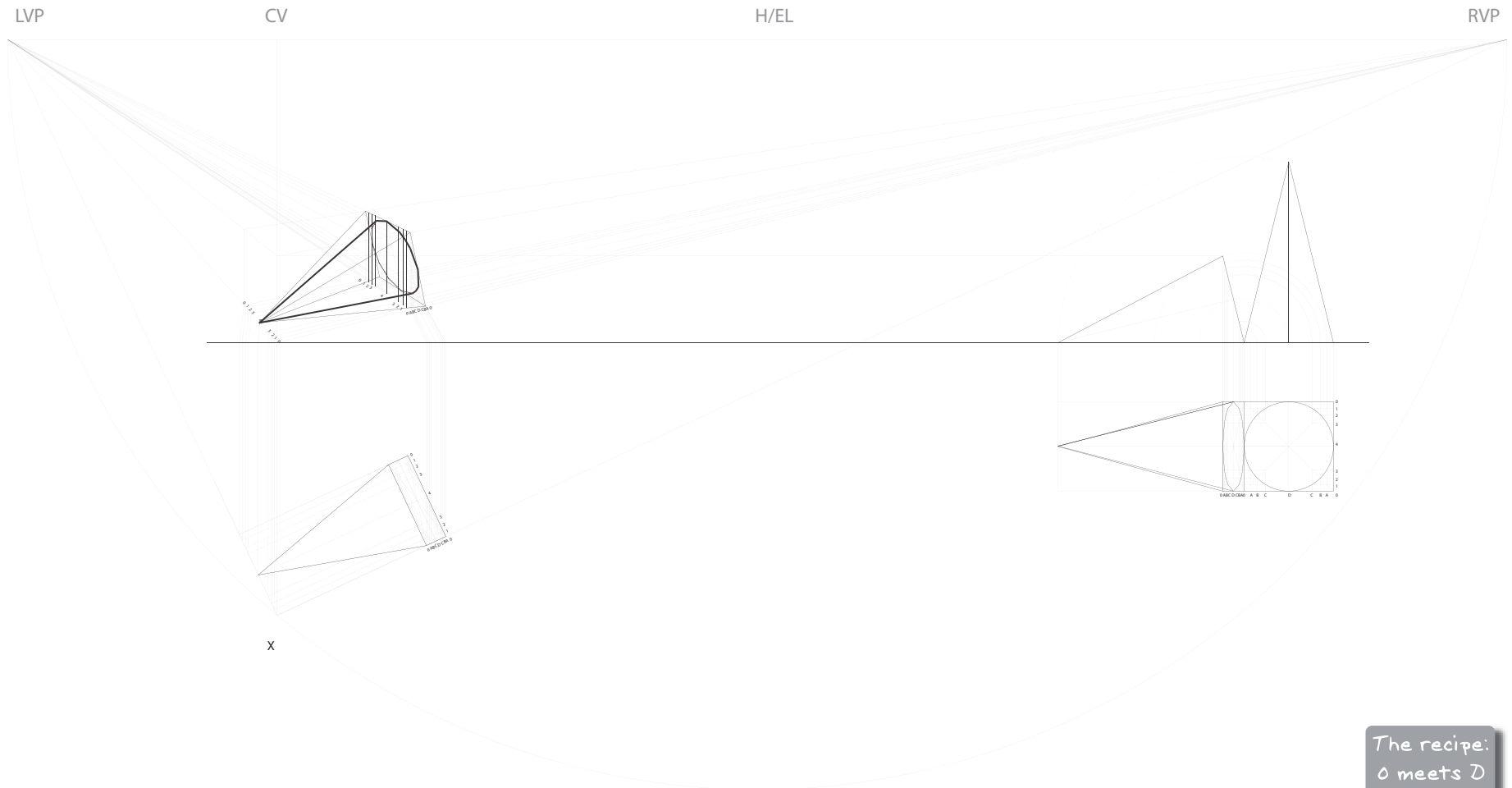

The recipe:
0 meets D
1 meets C
2 meets B
3 meets A
4 meets O